

AC FAN SK205AP

205 X 205 X 72mm(8")710~620 CFM

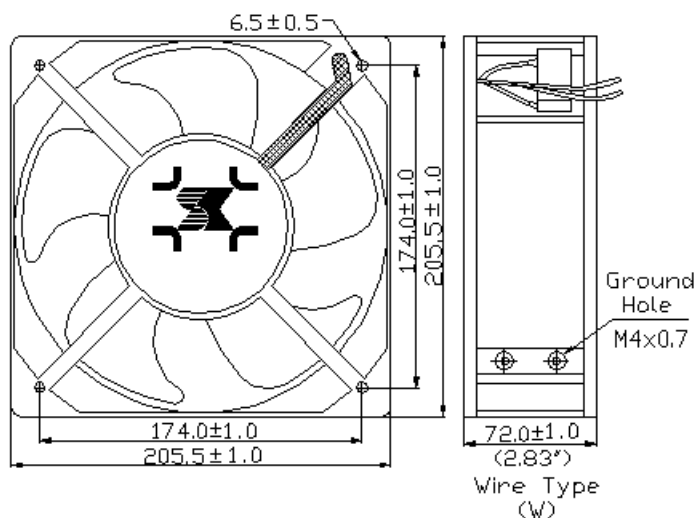

- 馬達 Motor: Single phase induction capacitor motor, thermally protected
- 外殼 Housing / Frame: Die-cast aluminum, Painted black (AP) or Plated (AN)
- 風葉 Impeller: Glass reinforced thermoplastic, UL 94V-0
- 軸承 Bearing Type: Two-ball bearing
- 接電方式 Connecting: T-Terminal push-on type or W-Lead wire type
- 耐壓 Dielectric Strength: 1 min. at 1,500VAC, 50/60Hz
- 溫度範圍 Operating Temp: Recommended ambient range -20°C~+70°C
- 壽命 Life Expectancy: 60,000 hours at 25°C
40,000 hours at 65°C
- 淨重 Net Weight: 2.1 kg (4.6 pounds)
- 檢定 Safety Approvals: UL, CUL, TUV, CE, RoHS

SK205 P-Q Curves

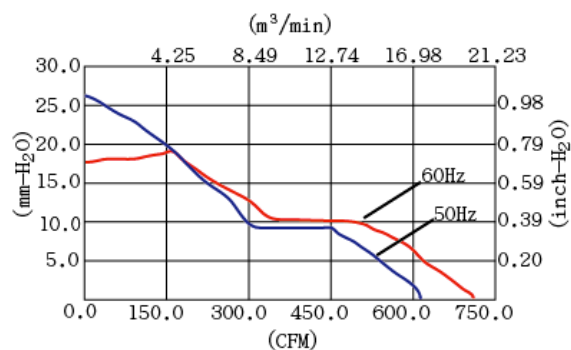

型號 Model No.	電壓 Rated VAC	頻率 Freq. Hz	電流 Rated Input Amp	功率 Rated Input Watt	轉速 Rated Speed RPM	最大風量 Max. Air Flow		最大風壓 Max. Static Pressure		噪音 Noise Level (dB)
						m ³ /min	CFM	mm-H ₂ O	inch-H ₂ O	
SK205AP-11-1	115 (100V~120V)	50/60	0.60/1.00	65/102	2850/3250	17.5/20.1	620/710	26.4/17.4	1.04/0.69	67/71
SK205AP-22-1	230 (200V~240V)	50/60	0.30/0.49	65/102	2850/3250	17.5/20.1	620/710	26.4/17.4	1.04/0.69	68/71